

KS/KSE 1031 Multipole Cable Mounted Receptacles

All dimensions see note 1)

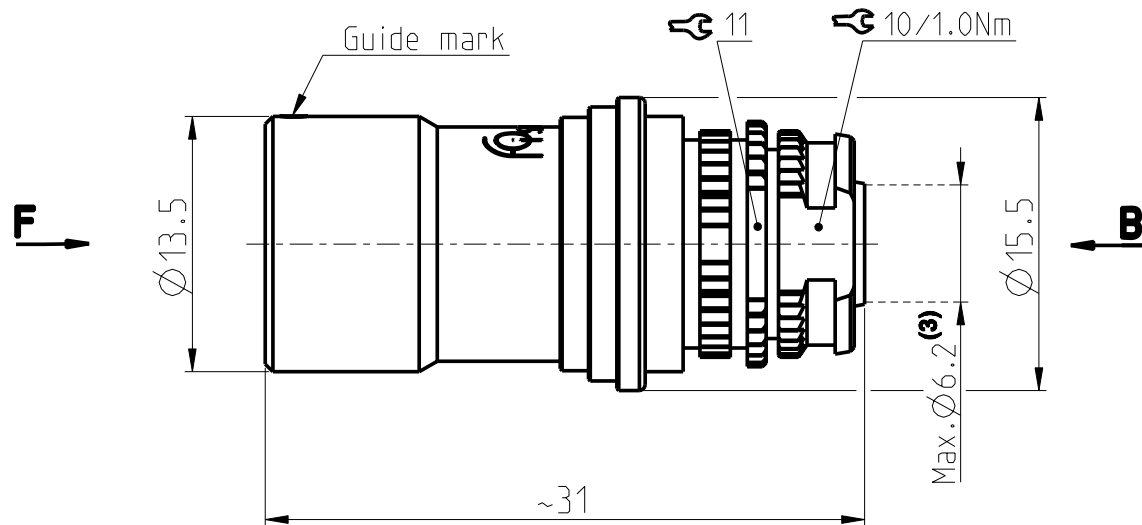

Contact polarity A

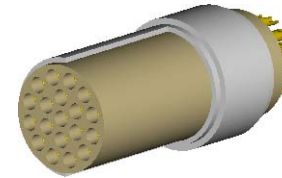

Contact polarity Z

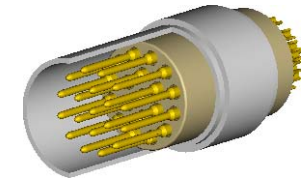

CONTACT CONFIGURATION		Contacts	Solder cup \varnothing		Crimp cup ⁽²⁾ \varnothing
1031	A Z 010	10	0.79		0.60
1031	A Z 012	12	0.79		0.60
1031	A Z 019	19	0.43		0.43

Contact configuration for polarity A (View from B)

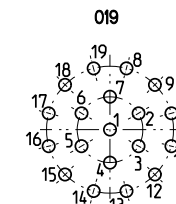
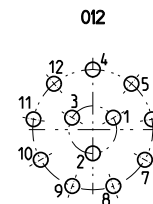
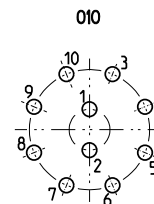

Keying codes (View from F)

Code 1
(-1xx)

Code 2
(-2xx)

Code 3
(-3xx)

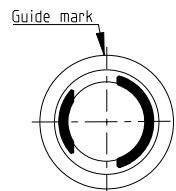
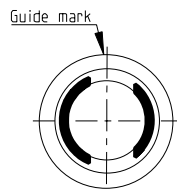
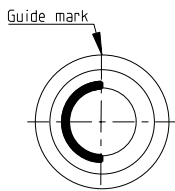

Contact configuration for polarity Z (View from B)

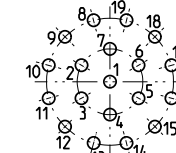
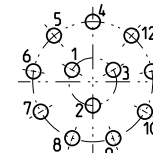
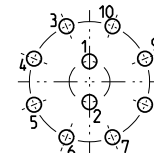

All dimensions in mm

600519

Rev.

1a

Pages

1/1

Notes :

- 1) All tolerances resulting from connector assembly are typically ± 0.3 mm
 - 2) For optimum crimping refer to available crimping manual.
 - 3) Max cable diameter below shield.
- Part number example : KSE 1031 A019-130

fischer
CONNECTORS

www.fischerconnectors.com