

KS/KSE 103 Multipole Cable Mounted Receptacles

All dimensions see note 1)

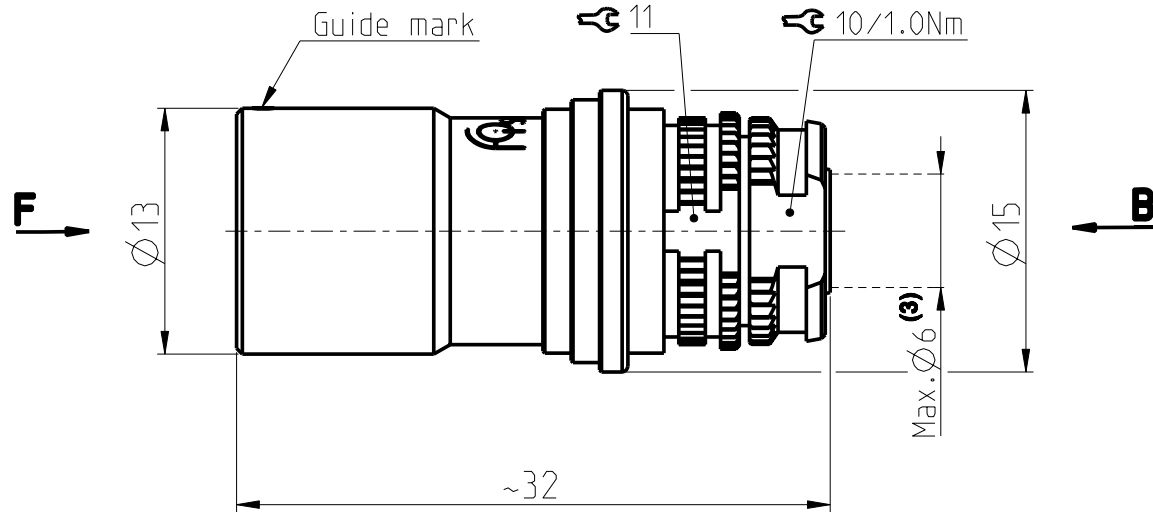

Contact polarity A

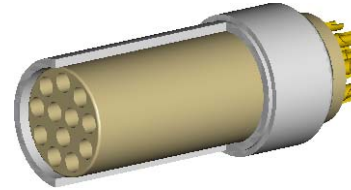

Contact polarity Z

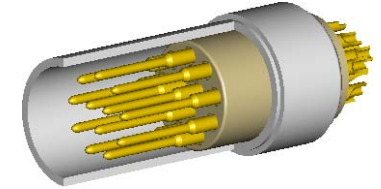

CONTACT CONFIGURATION			Contacts	Solder cup \varnothing	Crimp ⁽²⁾ \varnothing
103	A Z	051	2	1.18	1.18
103	A Z	052	3	1.18	-
103	A Z	053	4	0.79	-
103	A Z	054	5	0.79	0.80

Keying codes (View from F)

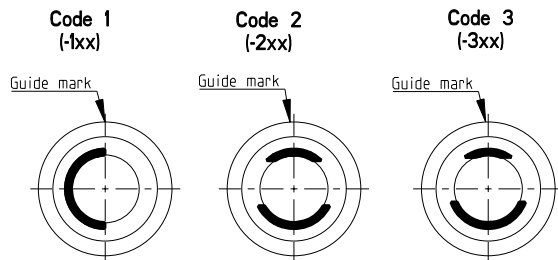

Contact configuration for polarity A (View from B)

051

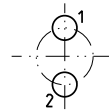

052

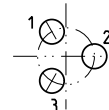

053

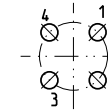

054

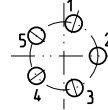

Contact configuration for polarity Z (View from B)

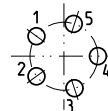
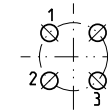
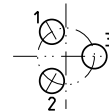
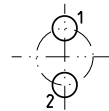

All dimensions in mm

600520

Rev.

1a

Pages

1/2

Notes :

- 1) All tolerances resulting from connector assembly are typically $\pm 0.3\text{mm}$
 - 2) For optimum crimping refer to available crimping manual.
 - 3) Max cable diameter below shield
- Part number example : KSE 103 A062-130

fischer
CONNECTORS

www.fischerconnectors.com

KS/KSE 103 Multipole Cable Mounted Receptacles

All dimensions see note 1)

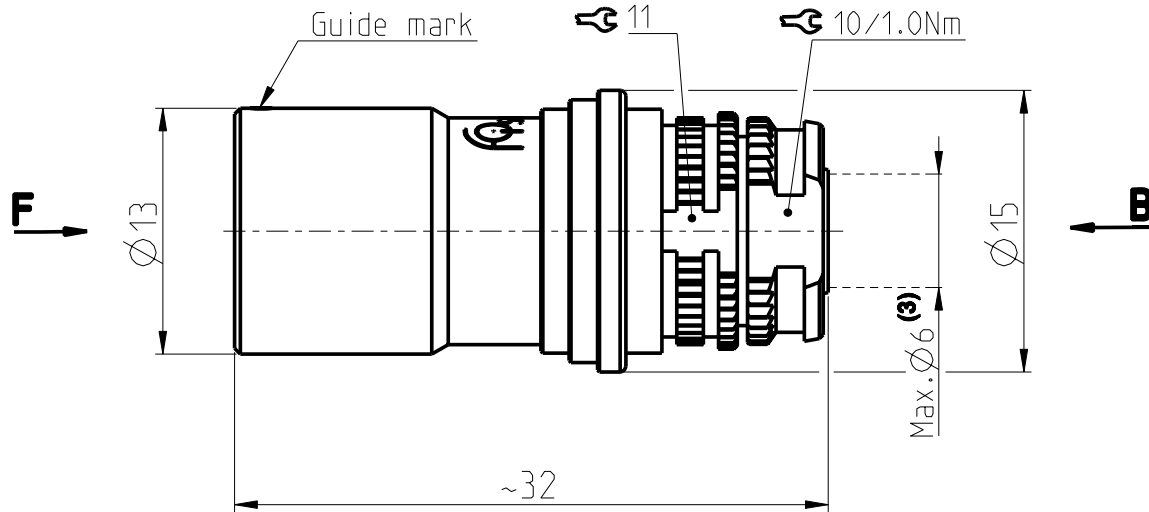

Contact polarity A

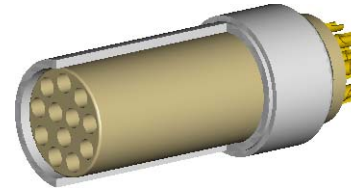

Contact polarity Z

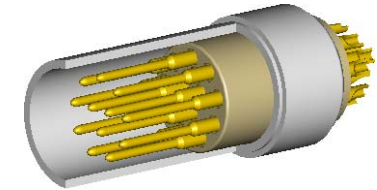

CONTACT CONFIGURATION	Contacts	Solder cup \varnothing	Crimp ⁽²⁾ \varnothing
103 A Z 056	6	0.79	0.60
103 A Z 057	7	0.79	0.60
103 A Z 058	8	0.79	0.60
103 A Z 062	12	0.43	0.43

Contact configuration for polarity A (View from B)

056 (4)

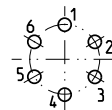

057 (4)

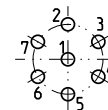

058

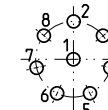

062

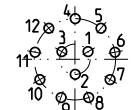

Keying codes (View from F)

Code 1 (-1xx)

Code 2 (-2xx)

Code 3 (-3xx)

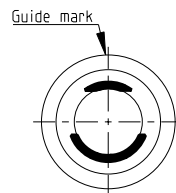
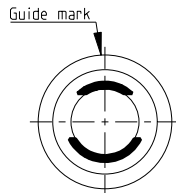
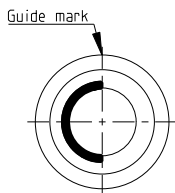

Contact configuration for polarity Z (View from B)

(4)

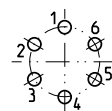

(4)

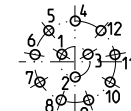
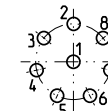
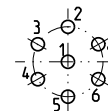

All dimensions in mm

600520

Rev.

1a

Pages

2/2

Notes :

- 1) All tolerances resulting from connector assembly are typically $\pm 0.3\text{mm}$
- 2) For optimum crimping refer to available crimping manual.
- 3) Max cable diameter below shield
- 4) Only valid for Code 1. For other codes please contact us.

Part number example : KSE 103 A062-130

fischer
CONNECTORS

www.fischerconnectors.com