

SS/SSC 1031 Multipole Plugs

All dimensions see note 1)

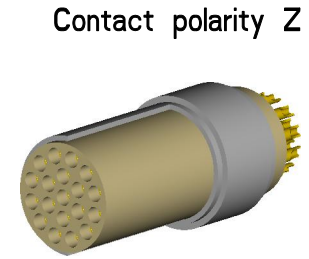
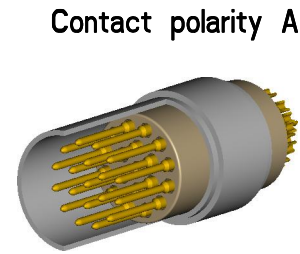
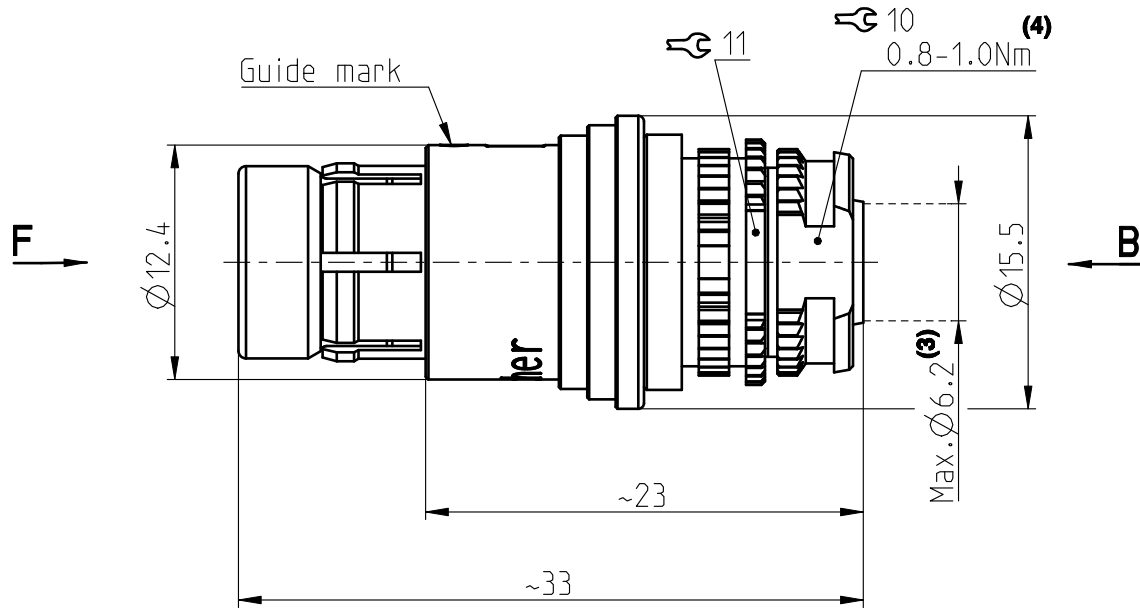

CONTACT CONFIGURATION	Contacts	Solder cup \varnothing	Crimp cup \varnothing ⁽²⁾
1031 A Z 010	10	0.79	0.60
1031 A Z 012	12	0.79	0.60
1031 A Z 019	19	0.43	0.43

Contact configuration for polarity A (View from B)

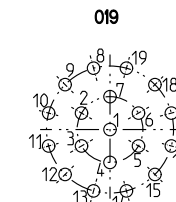
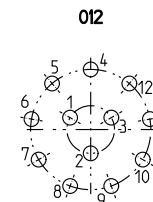
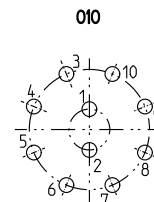

Contact configuration for polarity Z (View from B)

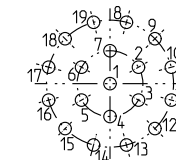
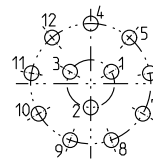
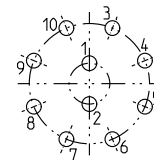

Keying codes (View from F)

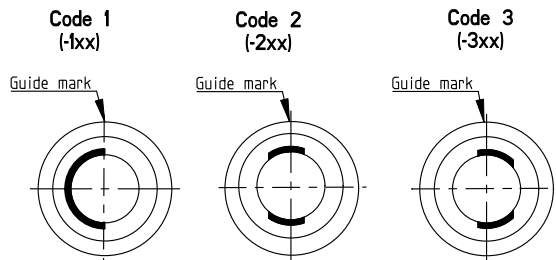

All dimensions in mm

600487

Rev.

2

Pages

1/1

Notes :

- 1) All tolerances resulting from connector assembly are typically ± 0.3 mm
 - 2) For optimum crimping refer to available crimping manual.
 - 3) Max cable diameter below shield.
- Part number example : SS 1031 A019-130

4) This torque is a recommended value that may be influenced by the characteristics of the cable. Tests have to be made to evaluate the exact value. To secure the back nut, we recommend the use of thread locking adhesive.



www.fischerconnectors.com