

DEE/U 1031 Multipole Receptacles

Contact polarity A

Contact polarity Z

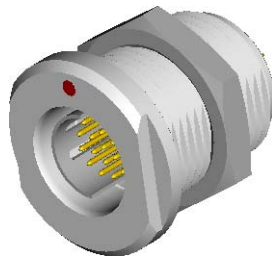

Panel:
Min.0
Max.12

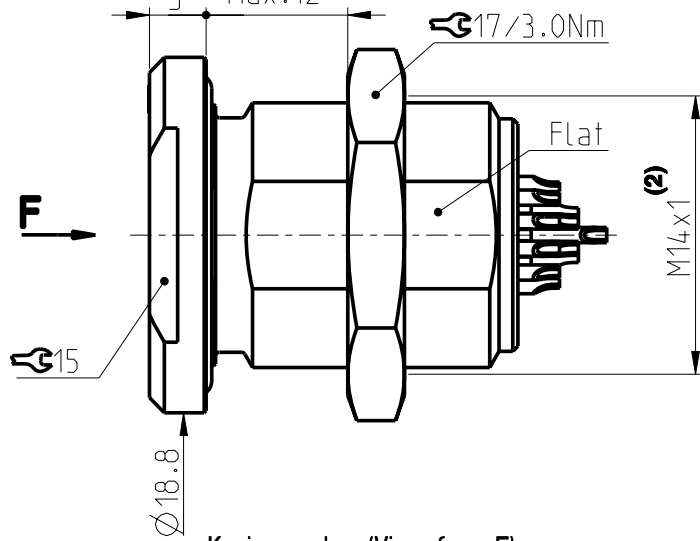
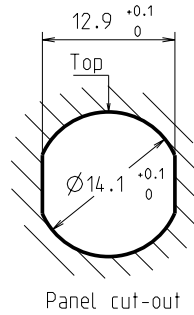

Keying codes (View from F)

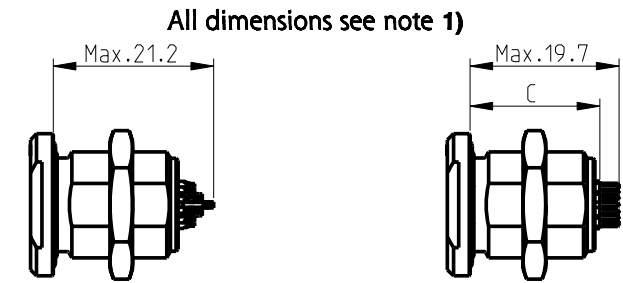
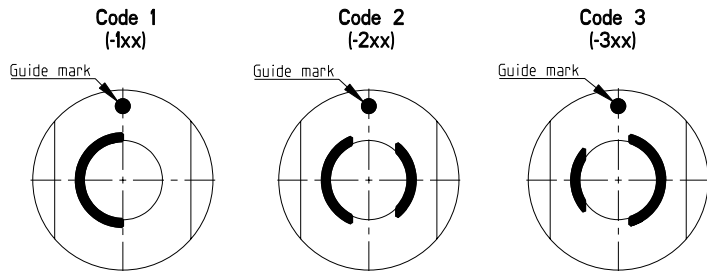

Solder (-x30/-x40)

PCB (-x39/-x49)

CONTACT CONFIGURATION	Contacts	Solder cup ϕ	C	PIN ϕ	
1031 A Z	010	10	0.79	17.2 -	0.5
1031 A Z	012	12	0.79	17.2 -	0.50
1031 A Z	019	19	0.43	17.2 -	0.40

Pin layout / PCB hole pattern for polarity A - View from F (3)

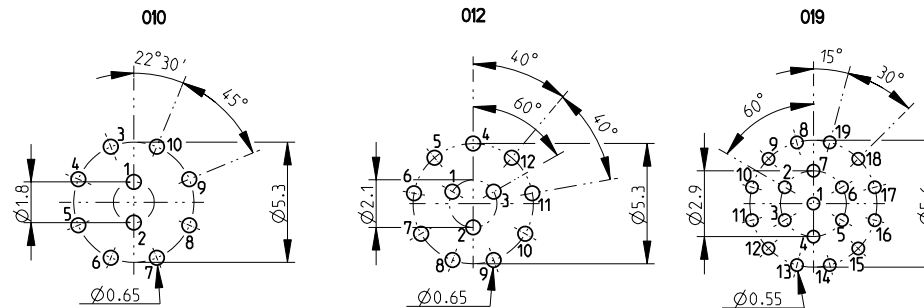

Polarity Z - View from F

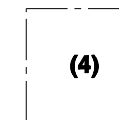
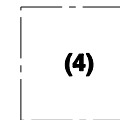
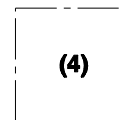

All dimensions in mm

600541

Rev.

4

Pages

1/1

Notes:

- 1) All tolerances resulting from connector assembly are typically ± 0.3 mm
- 2) If receptacle is screwed directly into threaded hole, oversize thread by $+0.05$ mm

3) Recommended PCB hole dimensions may be adjusted to application

4) Please contact us

Part number example : DEE 1031 A019-130

fischer
CONNECTORS

www.fischerconnectors.com