

B8

CHAPTER



FISCHER CORE SERIES **ALULITE™**

ULTRALIGHT | RUGGED | HIGHLY CONFIGURABLE

KEY FEATURES

- 50% lighter than brass equivalent
- Sealed up to IP68 or hermetic
- Wide range of colors for visual coding
- Over 10,000 mating cycles
- 360° EMC shielded

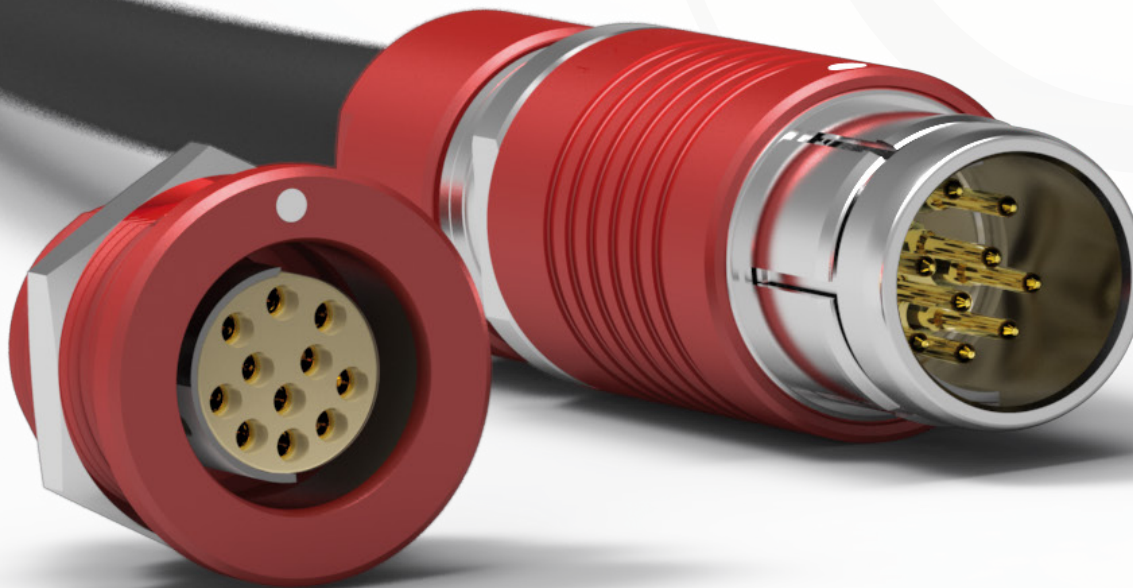

ALULITE

ALULITE



ALULITE

PLUGS



CABLE MOUNTED

- Body styles (S/SC; SS/SSC)..... B 8-4
- Technical dimensions B 8-5
- Part numbering..... B 8-6

RECEPTACLES



PANEL FRONT MOUNTED

- Body styles (D; DEU/DEE)..... B 8-7
- Technical dimensions B 8-8
- Part numbering..... B 8-9



PANEL REAR MOUNTED

- Body styles (DBPU/DBPE; DBPLU/DBPLE) B 8-7
- Technical dimensions B 8-10
- Part numbering..... B 8-11

FOR ALL ALULITE

- Electrical & contact configurations..... B 8-12
- Cable clamp sets B 8-19
- Accessories B 8-25
- Tooling B 8-29
- Technical information..... B 8-30
- Product specifications A-5

This catalog covers our standard connector solutions. For specific requests, including hybrid or custom connectors, please contact your local sales representative.

PLUGS*

CABLE MOUNTED



BODY STYLES	S	SC	SS	SSC
Locking system	Push-pull	Quick-release	Push-pull	Quick-release
Sealing	IP50/IP68	IP50/IP68	IP50/IP68	IP50/IP68
Design	Standard	Standard	Short/Overmolding	Short/Overmolding

RECEPTACLES*

PANEL FRONT MOUNTED



BODY STYLES	D	DEU	DEE
Sealing	IP50	IP68	Hermetic
Design	Rear-projecting	Rear-projecting	

PANEL REAR MOUNTED



BODY STYLES	DBPU	DBPE	DBPLU	DBPLE
Sealing	IP68	Hermetic	IP68	Hermetic
Design	Rear-projecting		Front-projecting	

*See full color selection in part numbering sections (pages B 8-6 B 8-9, B 8-11).

All dimensions and images shown are in millimeters and are for reference only.

PLUGS

CABLE MOUNTED



Body style		S	SC	SS	SSC	References to detailed information
Protection	Unsealed (IP50)	●	●	●	●	Sealing categories, page A-6
	Sealed up to IP68	●	●	●	●	
Locking system	Push-pull	●		●		Locking systems, page A-5
	Quick-release		●		●	
Contacts	Crimp	●	●	●	●	Electrical & contact configurations, page B8-12
	Solder	●	●	●	●	
Design	Colored housing	●	●	●	●	Body styles, page B8-3
	Shortened body			●	●	
Cabling	Cable clamp sets	●	●			Cable clamp sets, page B2-39
	Overmoldable			●	●	
	Heat shrinkable			●	●	

Other body styles available on request.

PLUGS

CABLE MOUNTED

S/SC

BODY STYLES

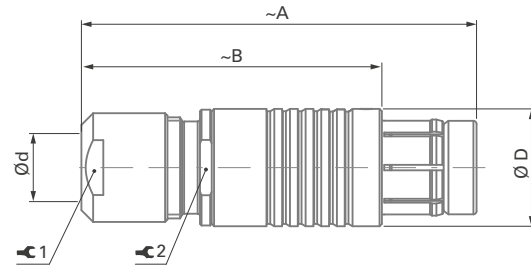

Series	Weight ¹⁾ (~g)	A	B	D	d max		1	Torque 1 [Nm]	2
					Unsealed	Sealed			
102	3	36	26	9	4.7	4.3	7	0.6	7
103	8	46	35	12	6.7	6.2	10	1.0	10
1031	8	48	38	13	7.2	6.7	12	1.5	11
104	11	50	38	15	9.1	8.7	12	2.0	13
105	19	62	47	18	10.7	10.7	15	3.5	16

¹⁾ Weight shown is without cable clamp set, overmolding or heat shrinking.
²⁾ Max. cable diameter below shield.

SS/SSC

BODY STYLES

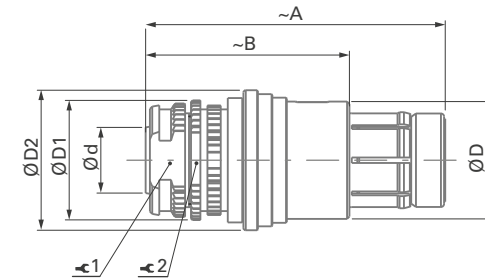

Series	Weight ¹⁾ (~g)	A	B	D	D1	D2	d max ²⁾	1	Torque 1 [Nm]	2
103	7	33	22	12.0	12.5	15.0	6.0	10	0.8 – 1.0	11
1031	8	33	23	12.4	13.0	15.5	6.2	10	0.8 – 1.0	11
104	8	38	26	15.0	15.3	18.0	8.0	12	1.5 – 2.0	13
105	16	44	29	18.0	18.4	21.2	10.0	15	1.5 – 2.0	16

PLUGS

The configurator is designed for multipole contact blocks only. For coax or triax blocks, please contact us.



Example:

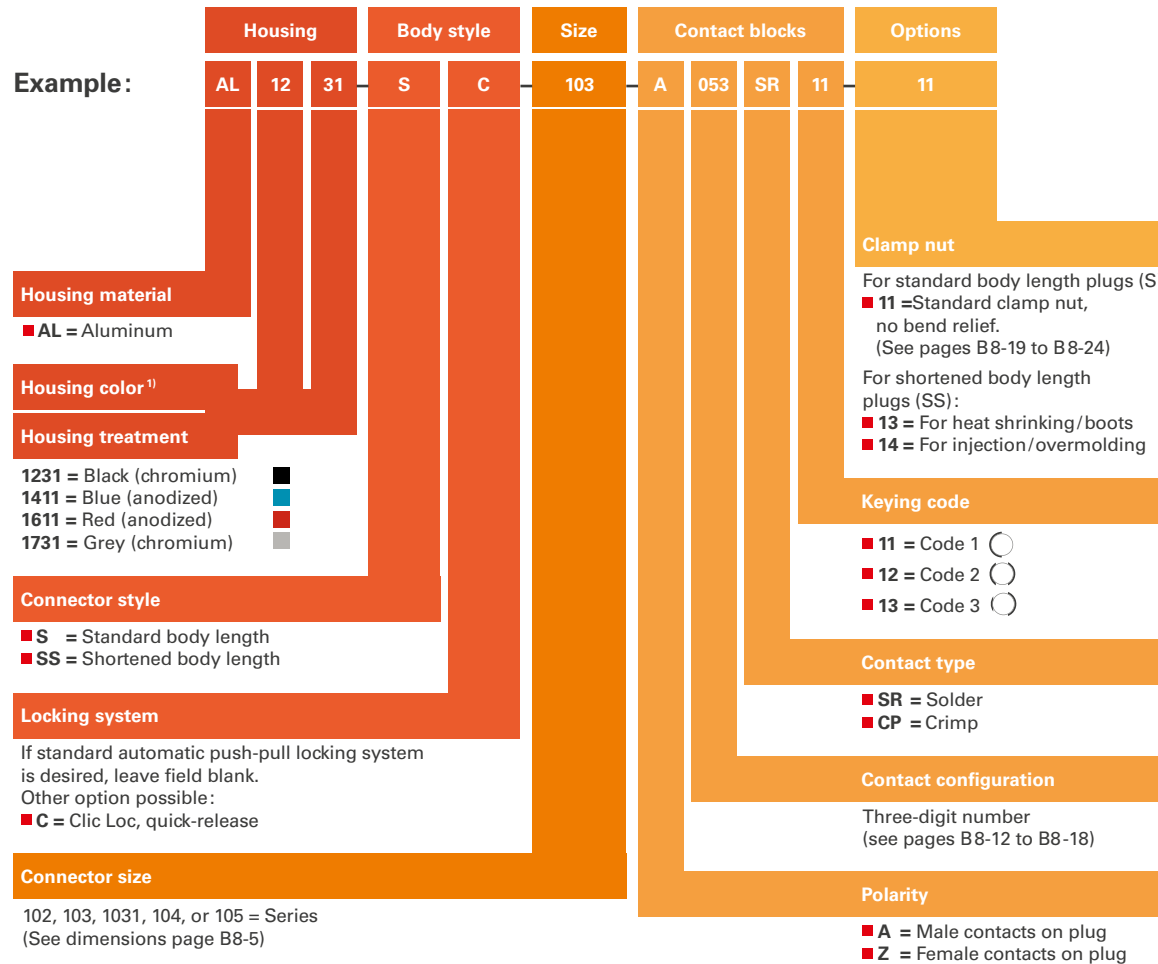

¹⁾ Fischer Connectors cannot be held liable for small color variations that may appear from one batch to another.

Example 1

AL1231-S-103-A062SR11-11

Example 2

AL1231-S-103-A053SR11-11
AL1731-SS-102-A056SR12-13

RECEPTACLES

PANEL MOUNTED									
Body Style		D	DEU	DEE	DBPU	DBPE	DBPLU	DBPLE	References to detailed information
Protection	Unsealed (IP50)	●	●	●	●	●	●	●	Sealing categories, page A-6
	Sealed up to IP68		●	●	●	●	●	●	
	Hermetic			●		●		●	
Contacts	Crimp	●							Electrical & contact configurations, page B8-12
	Solder	●	●	●	●	●	●	●	
	PCB	●	●	●	●	●	●	●	
Design	Colored housing	●	●	●	●	●	●	●	Body styles, chapter B8-3
	Flush	●	●	●	●	●			
	Front-projecting						●	●	
Assembly	Front-mounting	●	●	●					
	Rear-mounting				●	●	●	●	

Other body styles available on request.

ALULITE

RECEPTACLES

PANEL FRONT MOUNTED

D

BODY STYLES

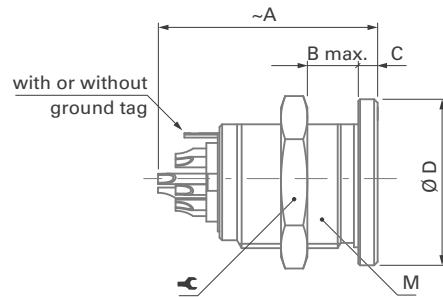

Series	Weight ¹⁾ (~g)	A	B max	C	D	M	⚙	Torque [Nm]
102	3	19	9	1.5	11	9x0.5	11	1.3
103	5	23	8	1.5	14	12x1	14	2.5
1031	8	25	10	2.0	16	14x1	17	3.0
104	9	25	11	2.2	19	15x1	17	4.0
105	18	32	15	2.0	22	18x1	22	6.0

DEU/DEE

BODY STYLES

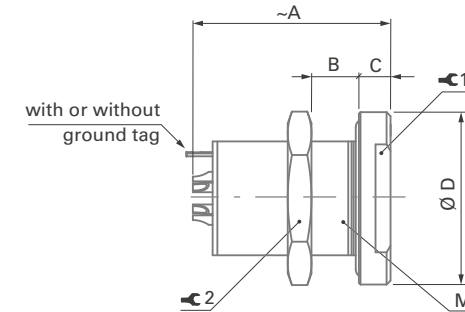

Series	Weight ¹⁾ (~g)	A	B min/max	C	D	M	⚙ ₁	Torque 1 [Nm]	⚙ ₂
102	4	20	8/10 ²⁾	2.5	14	9x0.5	11	1.3	11
103	9	23	0/12	3.0	18	14x1	14	3.0	17
1031	10	25	0/12	3.0	19	14x1	15	3.0	17
104	13	25	0/15	4.0	22	16x1	17	4.5	19
105	28	33	0/18	4.0	27	20x1	22	6.5	25

Series	G	H	Fig.
102	9.1	8.5	1
103	12.1	11.2	1
1031	14.1	12.1	2
104	15.1	14.2	1
105	18.1	17.3	1

PANEL CUT OUT

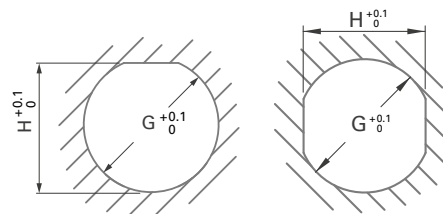

Fig. 1

Fig. 2

Series	G	H	Fig.
102	10.1	9.2	3
103	14.1	12.5	3
1031	14.1	13.0	2
104	16.1	14.5	3
105	20.1	18.5	3

PANEL CUT OUT

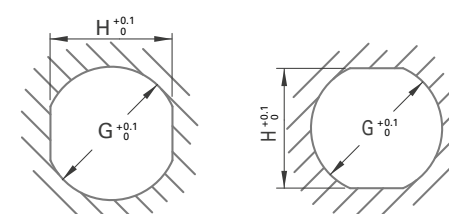

Fig. 2

Fig. 3

¹⁾Weight includes nut.

²⁾In the 102 Series only, the thread does not go all the way to the flange but stops 8 mm away. For panels thinner than 8 mm, spacers are available.

RECEPTACLES

PANEL FRONT MOUNTED

The configurator is designed for multipole contact blocks only.
For coax or triax blocks, please contact us.



SPACERS

FOR DEU/DEE BODY STYLES OF THE 102 SERIES

Panel width	Spacer part number
0.5 - 3.0	102.550
2.5 - 5.5	102.551
5.0 - 8.0	102.552

Material: aluminium

All dimensions and images shown are in millimeters and are for reference only.

Example: AL 12 31 - D EE - 103 - A 062 SR 11 - 11 G 11

Housing material
 ■ AL = Aluminum

Housing color¹⁾

Housing treatment
 1231 = Black (chromium) ■
 1411 = Blue (anodized) ■
 1611 = Red (anodized) ■
 1731 = Grey (chromium) ■

Connector style
 ■ D = Flush (vs. panel) Front-mounting receptacle

Sealing level
 If no sealing level is desired, leave field blank.
 Other options possible:
 ■ EU = Sealed (IP68) even unmated
 ■ EE = Hermetic

Connector size
 102, 103, 1031, 104, or 105 = Series
 (See dimensions section)

¹⁾Fischer Connectors can not be held liable for small color variations that may appear from one batch to another.

Example 1
AL1611-DEU-1031-A019SR11-11G11

Example 2
AL1411-DEU-102-A053SR11-11G11

Housing
 AL 12 31

Body style
 D EE

Size
 103

Contact blocks
 A 062 SR 11

Options
 11 G 11

Nut type
 ■ 11 = Hexagonal
 ■ 12 = None

Grounding
 ■ G = Yes ■ Z = No

O-ring at plug interface
 If 'No sealing level' chosen in section BC, leave field blank.
 Options possible if you selected 'Sealed (IP68) even unmated' or 'Hermetic':
 ■ 11 = Viton
 ■ 12 = EPDM (low temperature)

Keying code
 ■ 11 = Code 1 ○
 ■ 12 = Code 2 ○
 ■ 13 = Code 3 ○

Contact type
 Options possible if no sealing level is required:
 ■ SR = Solder
 ■ CP = Crimp "D" only
 ■ PB = PCB
 Options possible if selected sealing level is 'Sealed (IP68) even unmated' or 'Hermetic':
 ■ SR = Solder
 ■ PB = PCB

Contact configuration
 Three-digit number
 (see pages B8-12 to B8-18)

Polarity
 ■ A = Female contacts on receptacle
 ■ Z = Male contacts on receptacle

ALULITE

RECEPTACLES

PANEL REAR MOUNTED

DBPU/DBPE

BODY STYLES

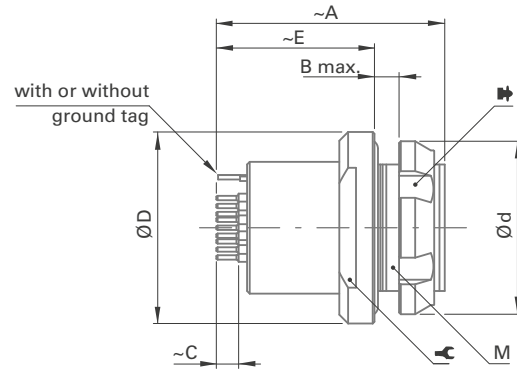

SERIES	Weight ¹⁾ (~g)	A ²⁾	B max	D	d	E ²⁾	C ²⁾	M ³⁾		Torque [Nm]
102	3	20	3.5	14	12	13	2.54	9x0.5	11	1.3
103	8	26	4.0	18	18	18	2.54	14x1	15	3.0
1031	8	23	3.0	19	18	15	2.54	14x1	15	3.0
104	11	26	4.0	22	20	18	2.54	16x1	17	4.5
105	26	30	5.0	27	25	20	2.54	20x1	22	6.5

¹⁾ Weight includes nut.
²⁾ Pin length and diameter vary according to contact configuration. Contact us for more information.
³⁾ For information on nutdrivers (), see Tooling page B8-29.

SERIES	G	H	Fig.
102	9.1	8.0	3
103	14.1	12.5	3
1031	14.1	12.1	2
104	16.1	14.5	3
105	20.1	18.5	3

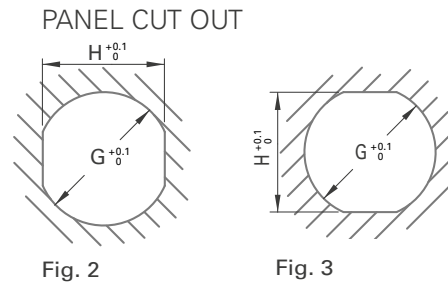

DBPLU/DBPLE

BODY STYLES

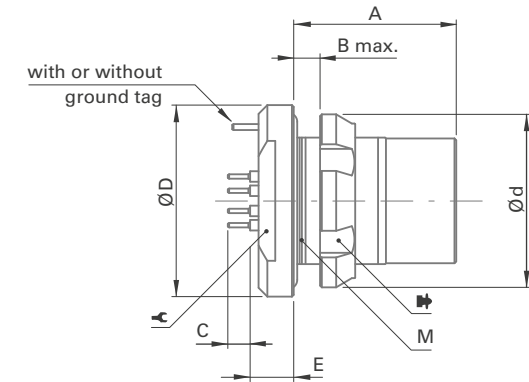

SERIES	Weight ¹⁾ (~g)	A	B	C	d	D	E	M ³⁾		Torque [Nm]
102	3	14.2	4.5	2.54	13	14	3.6	10x0.5	11	1.5
103	8	16.5	5.0	2.54	18	18	4.2	14x1	15	3.0
1031	8	16.0	5.5	2.54	20	19	4.2	15x1	15	4.0
104	11	18.5	6.5	2.54	20	22	5.0	16x1	17	4.5
105	26	22.5	8.0	2.54	25	27	5.5	20x1	22	6.5

* - Pin for PCB contacts versions; all Series.
 - Tag for solder contact versions; Series 103 to 107.
 - Barrel for solder contact versions; Series 102.

SERIES	G	H	Fig.
102	10.1	9.2	3
103	14.1	12.5	3
1031	15.1	13.5	2
104	16.1	14.5	3
105	20.1	18.5	3

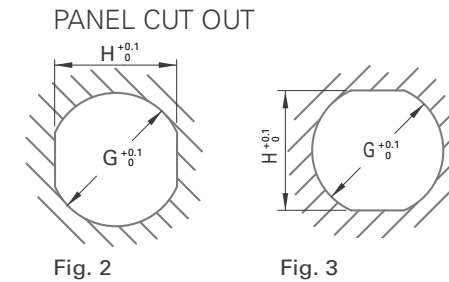

RECEPTACLES

PANEL REAR MOUNTED

The configurator is designed for multipole contact blocks only. For coax or triax blocks, please contact us.



Example: AL 12 31 DBPL E 103 A 062 PB 11 11 G 13

	Housing			Body style		Size	Contact blocks				Options		
Housing material	AL	12	31	DBPL	E	103	A	062	PB	11	11	G	13
Housing color¹⁾													
Housing treatment													
1231 = Black (chromium)													
1411 = Blue (anodized)													
1611 = Red (anodized)													
1731 = Grey (chromium)													
Connector style													
DBP = Flush (vs. panel) Rear-mounting receptacle													
DBPL = Front-projecting (vs. panel) Rear-mounting receptacle													
Sealing level													
U = Sealed (IP68) even unmated													
E = Hermetic													
Connector size													
102, 103, 1031, 104 or 105 = Series (See dimensions section)													
Contact blocks													
Options													
Nut type													
13 = Slotted nut													
Grounding													
G = Yes Z = No													
O-ring at plug interface													
11 = Viton 12 = EPDM (low temperature)													
Keying code													
11 = Code 1 <input type="radio"/> 12 = Code 2 <input type="radio"/> 13 = Code 3 <input type="radio"/>													
Contact type													
SR = Solder PB = PCB													
Contact configuration													
Three-digit number (see pages B8-12 to B8-18)													
Polarity													
A = Female contacts on receptacle Z = Male contacts on receptacle													

Example 1:
AL1231-DBPLU-102-A059PB12-12G13

Example 2:
AL1231-DBPLE-102-Z054SR11-11G13

¹⁾ Fischer Connectors can not be held liable for small color variations that may appear from one batch to another.

102 SERIES

● = Standard ○ = Option

Reference	Pin layout	Number of contacts	Contact types			Insulating material	Contact ø [mm]	Wire size ²⁾		Test voltage ⁵⁾ [kV] in mated position				Rated voltage ⁴⁾ rms [V]	Current ³⁾ [A]
			Solder	Crimp ⁶⁾	PCB			Solder contacts ¹⁾	Crimp contacts	AC rms		DC			
										Contact to body	Contact to contact	Contact to body	Contact to contact		
102 $\begin{matrix} A \\ Z \end{matrix}$ 051		2	●	● ⁷⁾	●	PEEK	0.9	max ø0.79mm AWG21 [1] AWG22 [7/30]	max ø0.83mm min ø0.48mm AWG22-26	1.3	1.7	1.8	2.4	≤ 250	9.2
102 $\begin{matrix} A \\ Z \end{matrix}$ 052		3	●		●	PEEK	0.9	max ø0.79mm AWG21 [1] AWG22 [7/30]	-	1.3	1.3	1.8	1.6	≤ 250	8.2
102 $\begin{matrix} A \\ Z \end{matrix}$ 053		4	●	●	●	PEEK	0.7	max ø0.79mm AWG21 [1] AWG22 [7/30]	max ø0.62mm min ø0.38mm AWG24-28	1.2	1.2	1.7	1.8	≤ 200	5.5
102 $\begin{matrix} A \\ Z \end{matrix}$ 054		5	●	●	●	PEEK	0.7	max ø0.79mm AWG21 [1] AWG22 [7/30]	max ø0.62mm min ø0.38mm AWG24-28	0.8	1.0	1.3	1.8	≤ 160	5.2
102 $\begin{matrix} A \\ Z \end{matrix}$ 056		7	●	●	●	PEEK	0.5	max ø0.43mm AWG26 [1] AWG28 [19/40]	max ø0.43mm min ø0.20mm AWG28-32	0.8	1.0	1.3	1.8	≤ 160	2.0
102 $\begin{matrix} A \\ Z \end{matrix}$ 059		9	●		●	PEEK	0.5	max ø0.43mm AWG26 [1] AWG28 [19/40]	-	0.8	1.1	1.2	1.8	≤ 160	1.7

¹⁾ Wire gauge stranding values are in brackets.

²⁾ For a given AWG, the diameter of some stranded conductor designs could exceptionally be larger than the hole diameter of the barrel. Testing may be required.

³⁾ Current per contact at 40°C temperature rise measured on the basic curve according to IEC 60512-5-2-5b. For the max. operating current a reduction factor must be used and limitations due to the size of the wires and the permissible upper temperature limit of the materials employed must be taken into account. See page A-12 for details.

⁴⁾ Recommended operating voltage at sea level measured according to IEC 60664-1.

⁵⁾ Measured with S plug and D receptacle.

⁶⁾ Plug with crimp contacts must be used with unshielded clamps only.

⁷⁾ Only available for A polarity plugs.

103 & 1031 SERIES

● = Standard ○ = Option

References	Pin layout	Number of contacts	Contact types			Insulating material	Contact ø [mm]	Wire size ²⁾		Test voltage ⁵⁾ [kV] in mated position				Rated voltage ⁴⁾ rms [V]	Current ³⁾ [A]
			Solder	Crimp	PCB			Solder contacts ¹⁾	Crimp contacts	AC rms		DC			
										Contact to body	Contact to contact	Contact to body	Contact to contact		
103 A Z 051		2	●	●	●	PEEK	1.3	max ø1.18mm AWG17 [1] AWG18 [16/30]	max ø1.18mm min ø0.58mm AWG18-24	1.5	2.2	2.2	3.0	≤ 250	13
103 A Z 052		3	●		●	PEEK	1.3	max ø1.18mm AWG17 [1] AWG18 [16/30]	-	1.2	1.5	1.8	2.0	≤ 250	12
103 A Z 053		4	●		●	PEEK	0.9	max ø0.79mm AWG21 [1] AWG22 [7/30]	-	1.2	1.6	2.0	2.4	≤ 250	7.0
103 A Z 054		5	●	●	●	PEEK	0.9	max ø0.79mm AWG21 [1] AWG22 [7/30]	max ø0.83mm min ø0.48mm AWG22-26	1.1	1.4	1.9	2.2	≤ 250	6.8
103 A Z 056		6	●	●	●	PEEK	0.7	max ø0.79mm AWG21 [1] AWG22 [7/30]	max ø0.62mm min ø0.38mm AWG24-28	1.0	1.3	2.0	2.0	≤ 250	5.2
103 A Z 057		7	●	●	●	PEEK	0.7	max ø0.79mm AWG21 [1] AWG22 [7/30]	max ø0.62mm min ø0.38mm AWG24-28	1.0	1.3	2.0	2.0	≤ 250	5.0
103 A Z 058		8	●		●	PEEK	0.7	max ø0.79mm AWG21 [1] AWG22 [7/30]	max ø0.62mm min ø0.38mm AWG24-28	0.8	1.1	1.4	1.9	≤ 200	3.8
103 A Z 062		12	●	●	●	PEEK	0.5	max ø0.43mm AWG26 [1] AWG28 [19/40]	max ø0.43mm min ø0.20mm AWG28-32	0.9	1.2	1.5	1.8	≤ 200	2.0
1031 A Z 010		10	●	●	●	PEEK	0.7	max ø0.79mm AWG21 [1] AWG22 [7/30]	max ø0.62mm min ø0.38mm AWG24-28	1.4	1.5	2.0	2.2	≤ 250	4.5
1031 A Z 012		12	●	●	●	PEEK	0.7	max ø0.79mm AWG21 [1] AWG22 [7/30]	max ø0.62mm min ø0.38mm AWG24-28	1.4	1.5	2.0	2.2	≤ 250	4.2
1031 A Z 019		19	●	●	●	PEEK	0.5	max ø0.43mm AWG26 [1] AWG28 [19/40]	max ø0.43mm min ø0.20mm AWG28-32	1.2	0.9	2.0	1.5	≤ 250	2.5

¹⁾ Wire gauge stranding values are in brackets.

²⁾ For a given AWG, the diameter of some stranded conductor designs could be larger than the hole diameter of the barrel. Testing maybe required.

³⁾ Current per contact at 40°C temperature rise measured on the basic curve according to IEC 60512-5-2-5b. For the max. operating current a reduction factor must be used and limitations due to the size of the wires and the permissible upper temperature limit of the materials employed must be taken into account. See page A-12 for details.

⁴⁾ Recommended operating voltage at sea level measured according to IEC 60664-1.

⁵⁾ Measured with S plug and D receptacle.

ALULITE

104 SERIES

● = Standard ○ = Option

Reference	Pin layout	Number of contacts		Contact types			Insulating material	Contact ø [mm]	Wire size ²⁾		Test voltage ⁶⁾ [kV] in mated position				Rated voltage ⁴⁾ rms [V]	Current ³⁾ [A]
				Solder	Crimp	PCB			Solder contacts ¹⁾	Crimp contacts	AC rms		DC			
											Contact to body	Contact to contact	Contact to body	Contact to contact		
104 A Z 051		2		●		○	PEEK PTFE	1.6	max ø1.86mm AWG13 [1] AWG14 [7/22]	-	1.8	2.2	2.8	3.2	≤ 500	20
104 A Z 040		3		○		●	PEEK PBT	1.6	max ø1.86mm AWG13 [1] AWG14 [7/22]	max ø1.78mm min ø1.17mm AWG14-18	1.6	2.0	2.6	3.0	≤ 500	18
104 A Z 037		4		●	●	●	PEEK	1.3	max ø1.18mm AWG17 [1] AWG18 [16/30]	max ø1.18mm min ø0.58mm AWG18-24	1.8	2.2	2.5	3.0	≤ 500	12
104 A Z 087		4	2	●		●	PBT	2.3	max ø2.48mm AWG11 [1] AWG12 [7/20]	-	1.5	1.6	2.2	2.5	≤ 400	28
			2					0.9	max ø0.79mm AWG21 [1] AWG22 [7/30]	-						
104 A Z 053		5		●		●	PEEK	1.3	max ø1.18mm AWG17 [1] AWG18 [16/30]	-	1.4	1.7	2.4	2.7	≤ 320	11
104 A Z 065		6		●	●	●	PEEK	0.9	max ø0.79mm AWG21 [1] AWG22 [7/30]	max ø0.83mm min ø0.48mm AWG22-26	1.7	2.0	2.4	2.6	≤ 400	6.5
104 A Z 054		7		●		●	PEEK	0.9	max ø0.79mm AWG21 [1] AWG22 [7/30]	-	1.5	1.8 ⁵⁾	2.2	2.0 ⁵⁾	≤ 320	6.5
											2.1	2.8				

¹⁾ Stranding values are in brackets.

²⁾ For a given AWG, the diameter of some stranded conductor designs could be larger than the hole diameter of the barrel. Testing may be required.

³⁾ Current per contact at 40°C temperature rise measured on the basic curve according to IEC 60512-5-2-5b. For the max. operating current a reduction factor must be used and limitations due to the size of the wires and the permissible upper temperature limit of the materials employed must be taken into account. See page A-12 for details.

⁴⁾ Recommended operating voltage at sea level measured according to IEC 60664-1.

⁵⁾ Test voltages between the contacts with the shortest distance.

⁶⁾ Measured with S plug and D receptacle.

104 SERIES

● = Standard ○ = Option

Reference	Pin layout	Number of contacts		Contact types			Insulating material	Contact ø [mm]	Wire size ²⁾		Test voltage ⁶⁾ [kV] in mated position				Rated voltage ⁴⁾ rms [V]	Current ³⁾ [A]
				Solder	Crimp	PCB			Solder contacts ¹⁾		AC rms		DC			
									max	min	Contact to body	Contact to contact	Contact to body	Contact to contact		
104 A Z 066		8		●	●	●	PEEK	0.9	max ø0.79mm AWG21 [1] AWG22 [7/30]	max ø0.83mm min ø0.48mm AWG22-26	1.5	1.5	2.5	2.5	≤ 320	6.2
104 A Z 055		1	●	●	●	PEEK	1.3	max ø1.18mm AWG17 [1] AWG18 [16/30]	-	2.4	2.2	3.8	3.6	≤ 250	12	
		8					0.9	max ø0.79mm AWG21 [1] AWG22 [7/30]	-	1.4	1.5	2.0	2.4		6.0	
104 A Z 056		11		●	●	●	PEEK	0.9	max ø0.79mm AWG21 [1] AWG22 [7/30]	max ø0.83mm min ø0.48mm AWG22-26	1.4	1.5	2.1	2.2	≤ 250	5.8
104 A Z 086		16		●	●	●	PEEK	0.7	max ø0.79mm AWG21 [1] AWG22 [7/30]	max ø0.62mm min ø0.38mm AWG24-28	1.0	1.5	1.6	2.2	≤ 200	4.0
104 A Z 092		19		●	●	●	PEEK	0.7	max ø0.79mm AWG21 [1] AWG22 [7/30]	max ø0.62mm min ø0.38mm AWG24-28	0.8	1.2	1.2	1.8	≤ 200	3.5
104 A124 ⁵⁾		27		●	●	●	PEEK	0.5	-	max ø0.43mm min ø0.20mm AWG28-32	1.2	0.5	1.8	0.5	≤ 200	2.0

¹⁾ Stranding values are in brackets.

²⁾ For a given AWG, the diameter of some stranded conductor designs could exceptionally be larger than the hole diameter of the barrel. Testing may be required.

³⁾ Current per contact at 40°C temperature rise measured on the basic curve according to IEC 60512-5-2-5b. For the max. operating current a reduction factor must be used and limitations due to the size of the wires and the permissible upper temperature limit of the materials employed must be taken into account. See page A-12 for details.

⁴⁾ Recommended operating voltage at sea level measured according to IEC 60664-1.

⁵⁾ Solder and PCB contact types available only for DBPU and DBPLU receptacles. Crimp contact type available only for plugs.

⁶⁾ Measured with S plug and D receptacle.

105 SERIES

● = Standard ○ = Option

Reference	Pin layout	Number of contacts		Contact types			Insulating material	Contact ø [mm]	Wire size ²⁾		Test voltage ⁶⁾ [kV] in mated position				Rated voltage ⁴⁾ rms [V]	Current ³⁾ [A]
				Solder	Crimp	PCB			Solder contact ¹⁾	Crimp contacts	AC rms		DC			
											Contact to body	Contact to contact	Contact to body	Contact to contact		
105 A Z 051		2		●			PEEK	2.0	max ø2.03mm AWG13 [1] AWG14 [7/22]	-	2.5	3.0	4.0	4.0	≤ 630	26
105 A Z 087		2		●			PEEK	3.0	max ø3.13mm AWG9 [1] AWG10 [105/30]	-	1.2	1.6	2.3	3.0	≤ 400	30
105 A Z 052		3		●			PEEK	2.0	max ø2.03mm AWG13 [1] AWG14 [7/22]	-	2.0	2.5	3.0	3.5	≤ 400	23
105 A Z 053 ⁵⁾		4		●			PEEK	2.0	max ø2.03mm AWG13 [1] AWG14 [7/22]	-	1.8	1.8	2.6	2.6	≤ 320	20
105 A Z 054 ⁵⁾		1	7	●			PEEK	2.0	max ø2.03mm AWG13 [1] AWG14 [7/22]	-	3.0	2.0	4.0	3.0	≤ 320	25
		6						1.3	max ø1.18mm AWG17 [1] AWG18 [16/30]	-	1.8	1.5	2.5	2.0		7.0
105 A Z 067		8		● ○			PEEK PTFE	1.3	max ø1.18mm AWG17 [1] AWG18 [16/30]	-	1.7	2.0	2.5	2.8	≤ 320	10
105 A 124		2	8	●			PEEK	2.3	max ø2.48mm AWG11 [1] AWG12 [7/20]	-	1.2	2.2	1.8	3.2	≤ 250	18.5
		6						1.3	max ø1.18mm AWG17 [1] AWG18 [16/30]	-	1.2	1.2	1.8	1.8		7.5
105 A Z 101 ⁵⁾		1	9	●		●	PEEK	2.0	max ø2.03mm AWG13 [1] AWG14 [7/22]	-	3.0	2.0	4.0	3.0	≤ 320	25
		8						1.3	max ø1.18mm AWG17 [1] AWG18 [16/30]	-	1.8	1.5	2.5	2.0		5.0

¹⁾ Stranding values are in brackets.

²⁾ For a given AWG, the diameter of some stranded conductor designs could exceptionally be larger than the hole diameter of the barrel. Testing may be required.

³⁾ Current per contact at 40°C temperature rise measured on the basic curve according to IEC 60512-5-2-5b. For the max. operating current a reduction factor must be used and limitations due to the size of the wires and the permissible upper temperature limit of the materials employed must be taken into account. See page A-12 for details.

⁴⁾ Recommended operating voltage at sea level measured according to IEC 60664-1.

⁵⁾ Contact dia. 2.0 is positioned to make contact first and break last.

⁶⁾ Measured with S plug and D receptacle.

105 SERIES

● = Standard ○ = Option

Reference	Pin layout	Number of contacts		Contact types			Insulating material	Contact ø [mm]	Wire size ²⁾		Test voltage ⁸⁾ [kV] in mated position				Rated voltage ⁴⁾ rms [V]	Current ³⁾ [A]
				Solder	Crimp	PCB			Solder contacts ¹⁾	Crimp contacts	AC rms		DC			
											Contact to body	Contact to contact	Contact to body	Contact to contact		
105 A Z 062		10		●	●	●	PEEK	1.3	max ø1.18mm AWG17 [1] AWG18 [16/30]	max ø1.18mm min ø0.58mm AWG18-24	1.7	2.0	2.5	2.7	≤ 320	9.0
105 A Z 069		12		●		●	PEEK	1.3	max ø1.18mm AWG17 [1] AWG18 [16/30]	-	1.4	1.5	1.8	2.0	≤ 250	8.0
105 A Z 104 ⁵⁾		3	13	●		●	PEEK	1.3	max ø1.18mm AWG17 [1] AWG18 [16/30]	-	2.5	1.5	3.8	2.2	≤ 320	14
		10						0.7	max ø0.79mm AWG21 [1] AWG22 [7/30]	-	1.3	1.5	1.8	2.2		1.0
105 A 127 ⁷⁾		3	13		●		PEEK	1.3	-	max ø1.18mm min ø0.58mm AWG18-24	3.0	2.8	4.8	3.9	≤ 320	14
		10						0.7	-	max ø0.62mm min ø0.38mm AWG24-28	3.1	1.1	4.7	1.9		1.0
105 A Z 058		15		●	●	●	PEEK	0.9	max ø0.79mm AWG21 [1] AWG22 [7/30]	max ø0.83mm min ø0.48mm AWG22-26	1.4	1.6	1.8	2.2	≤ 250	5.3
105 A Z 110 ⁶⁾		4	16	●		●	PEEK	1.6	max ø1.86mm AWG13 [1] AWG14 [7/22]	-	1.6	1.3	2.8	2.1	≤ 250	14
		12						0.7	max ø0.79mm AWG21 [1] AWG22 [7/30]	-	1.0	1.2	1.5	2.0		1.0
105 A Z 038		18		●	●	●	PEEK	0.9	max ø0.79mm AWG21 [1] AWG22 [7/30]	max ø0.83mm min ø0.48mm AWG22-26	1.4	1.6	1.8	2.2	≤ 200	4.5
105 A Z 093		24		●		●	PBT	0.7	max ø0.79mm AWG21 [1] AWG22 [7/30]	-	1.2	1.5	1.5	2.0	≤ 250	3.5
105 A Z 102		27		●	●	●	PEEK	0.7	max ø0.79mm AWG21 [1] AWG22 [7/30]	max ø0.62mm min ø0.38mm AWG24-28	1.2	1.5	1.5	2.0	≤ 250	3.0

¹⁾ Stranding values are in brackets.

²⁾ For a given AWG, the diameter of some stranded conductor designs could exceptionally be larger than the hole diameter of the barrel. Testing may be required.

³⁾ Current per contact at 40°C temperature rise measured on the basic curve according to IEC 60512-5-2-5b. For the max. operating current a reduction factor must be used and limitations due to the size of the wires and the permissible upper temperature limit of the materials employed must be taken into account. See page A-12 for details.

⁴⁾ Recommended operating voltage at sea level measured according to IEC 60664-1.

⁵⁾ Contacts dia. 1.3 are positioned to make contact first and break last.

⁶⁾ Contacts dia. 1.6 are positioned to make contact first and break last.

⁷⁾ Inverted polarity: female contacts on plug/male contact on receptacle

⁸⁾ Measured with S plug and D receptacle.

CONTACT TYPES

CRIMP CONTACTS



- Selectively annealed area
- Special tools required
- Limited range of wire sizes
- Each contact has a selectively annealed area which is crushed during assembly by specialized tooling to ensure proper termination of the wire to the contact.
- Commonly used for field termination or repair, as no soldering is required.
- Not available for sealed or hermetic connectors.

TOOLING FOR CRIMP CONTACTS

Series	Polarity	Contact diameter (mm)									
		0.5		0.7		0.9		1.3		1.6	
		Part number		Part number		Part number		Part number		Part number	
		Contact	Positioner	Contact	Positioner	Contact	Positioner	Contact	Positioner	Contact	Positioner
102	Male	200.2113	TX00.300	200.2884	TX00.304	200.2890	TX00.307	-	-	-	-
	Female	200.2114	TX00.302	200.2885	TX00.305	200.2892	TX00.309	-	-	-	-
103	Male	200.2113	TX00.300	200.2884	TX00.304	200.2890	TX00.307	200.2402	TX00.311	-	-
	Female	200.2114	TX00.302	200.2885	TX00.305	200.2892	TX00.309	200.2214	TX00.312	-	-
1031	Male	200.2172	TX00.301	200.2884	TX00.304	200.2890	TX00.307	200.2402	TX00.311	-	-
	Female	200.2183	TX00.303	200.2885	TX00.305	200.2892	TX00.309	200.2214	TX00.312	-	-
104	Male	200.2172	TX00.301	200.2884	TX00.304	200.2890	TX00.307	200.2402	TX00.311	200.1653	TX00.313
	Female	200.2183	TX00.303	200.2885	TX00.305	200.2892	TX00.309	200.2214	TX00.312	200.1654	TX00.314
105	Male	-	-	200.2884	TX00.304	200.2891	TX00.308	200.2403	TX00.338	200.1653	TX00.313
	Female	-	-	200.2886	TX00.306	200.2893	TX00.310	200.2214	TX00.312	200.1654	TX00.314
Crimp tool part number		TX00.240		TX00.240		TX00.240		TX00.240		TX00.242	

See section Tooling, section B 6-21, for description of Crimping Tool and Positioner.
 Please refer to www.fischerconnectors.com/technical for detailed information and assembly instructions.

CABLE CLAMP SETS

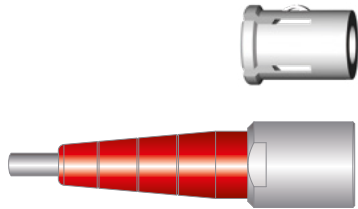

To guarantee excellent cable retention and strain relief, Fischer Connectors provides robust and high quality cable clamp sets:

- Collet style clamp system retains cable over large jacket surface area.
- Protection of small diameters and delicate conductors.
- Can be combined with cable bend reliefs for optimal performance.

Cable clamp sets are used with cable mounted connectors, except SS/SSC which require overmolding or heat shrinking techniques.

RANGE OVERVIEW: S, U & E CABLE CLAMP SETS

Fischer Connectors offers three types of cable clamps sets. The table below will help you select the one corresponding to your needs.

Cable clamp set	Do you need the interface between the cable and the connector to be sealed?	
	Unsealed	Sealed
S - Shielded	●	
U - Unshielded	●	
E - Environmental		●

Do you need the connector to be terminated to the cable shield?	
Unshielded	Shielded
	●
●	
●	●

PART NUMBERING

Cable clamp sets are ordered separately
Multipole low voltage
AL1731-S-102-A056SR11-11
Examples connector ordering line
AL1731-S-102-A056SR11-11
Clamp set ordering line
E3 102.5/2.0

See following pages for cable clamp set selection.

102 SERIES

S
SHIELDED

Shielded cable clamp with sleeve and clamp.

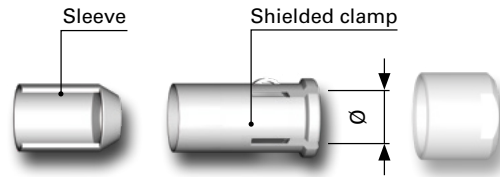

Cable dia. range	Collet Ø	Cable clamp set
1.5 - 2.1	2.1	E32 102.1/2.1 + A
2.1 - 2.6	2.6	E32 102.1/2.6 + A
2.6 - 3.1	3.1	E32 102.1/3.1 + A
3.1 - 3.6	3.6	E32 102.1/3.6 + A
3.6 - 4.1	4.1	E32 102.1/4.1 + A
4.1 - 4.3	4.3	E32 102.1/4.3 + A
4.3 - 4.7	4.7	E3 102.248 + A

U
UNSHIELDED

Unshielded, one-piece cable clamp.

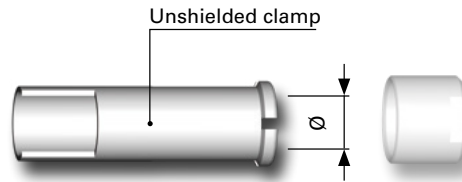

Cable dia. range	Collet Ø	Cable clamp set
1.4 - 2.0	2.0	E3 102.5/2.0
2.0 - 2.7	2.7	E3 102.5/2.7
2.7 - 3.5	3.5	E3 102.5/3.5
3.5 - 4.2	4.2	E3 102.5/4.2
4.2 - 4.7	4.7	E3 102.5/4.7

E
ENVIRONMENTAL

Environmentally sealed clamp for use with shielded or unshielded cables.

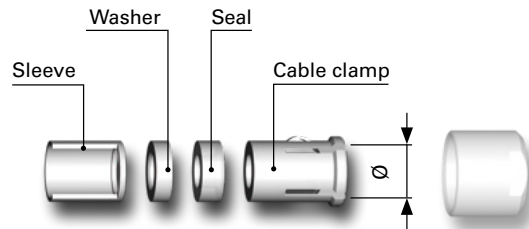

Cable dia. range	Collet Ø	Cable clamp set
1.5 - 2.1	2.1	E31 102.2/2.1 + B
2.1 - 2.6	2.6	E31 102.2/2.6 + B
2.6 - 3.1	3.1	E31 102.2/3.1 + B
3.1 - 3.6	3.6	E31 102.2/3.6 + B
3.6 - 4.1	4.1	E31 102.2/4.1 + B
4.1 - 4.3	4.3	E31 102.2/4.3 + B

103 SERIES

S SHIELDED

Shielded cable clamp with sleeve and clamp.

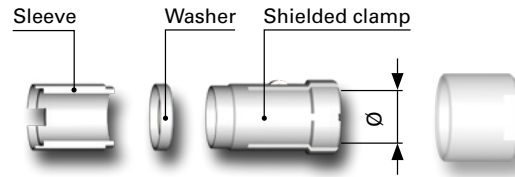

Cable dia. range	Collet Ø	Cable clamp set PEEK or PBT insulator
1.7 - 2.2	2.2	E31 103.1/2.2 + B
2.2 - 2.7	2.7	E31 103.1/2.7 + B
2.7 - 3.2	3.2	E31 103.1/3.2 + B
3.2 - 3.7	3.7	E31 103.1/3.7 + B
3.7 - 4.2	4.2	E31 103.1/4.2 + B
4.2 - 4.7	4.7	E31 103.1/4.7 + B
4.7 - 5.2	5.2	E31 103.1/5.2 + B
5.2 - 5.7	5.7	E31 103.1/5.7 + B
5.7 - 6.2	6.2	E31 103.1/6.2 + B
6.2 - 6.7	6.7	E31 103.1/6.7 + B

U UNSHIELDED

Unshielded, one-piece cable clamp.

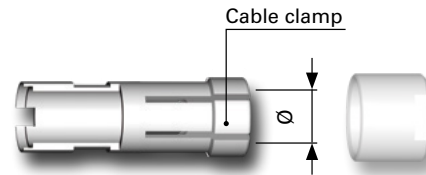

Cable dia. range	Collet Ø	Cable clamp set PEEK or PBT insulator
2.2 - 3.2	3.2	E3 103.6/3.2
3.2 - 4.2	4.2	E3 103.6/4.2
4.2 - 4.7	4.7	E3 103.6/4.7
4.7 - 5.2	5.2	E3 103.6/5.2
5.2 - 5.7	5.7	E3 103.6/5.7
5.7 - 6.2	6.2	E3 103.6/6.2
6.2 - 6.7	6.7	E3 103.6/6.7

E ENVIRONMENTAL

Environmentally sealed clamp for use with shielded or unshielded cables.

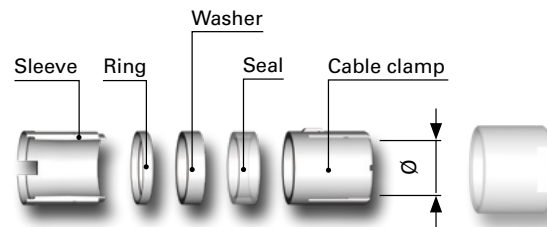

Cable dia. range	Collet Ø	Cable clamp set PEEK or PBT insulator
1.7 - 2.2	2.2	E31 103.2/2.2 + B
2.2 - 2.7	2.7	E31 103.2/2.7 + B
2.7 - 3.2	3.2	E31 103.2/3.2 + B
3.2 - 3.7	3.7	E31 103.2/3.7 + B
3.7 - 4.2	4.2	E31 103.2/4.2 + B
4.2 - 4.7	4.7	E31 103.2/4.7 + B
4.7 - 5.2	5.2	E31 103.2/5.2 + B
5.2 - 5.7	5.7	E31 103.2/5.7 + B
5.7 - 6.2	6.2	E31 103.2/6.2 + B

1031 SERIES

S
SHIELDED

Shielded cable clamp with sleeve and clamp.

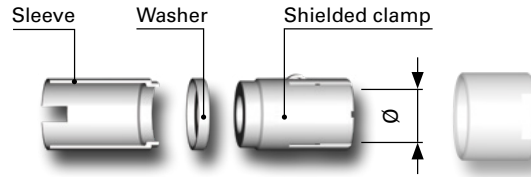

Cable dia. range	Collet Ø	Cable clamp set
2.2 - 2.7	2.7	E3 1031.1/2.7
2.7 - 3.2	3.2	E3 1031.1/3.2
3.2 - 3.7	3.7	E3 1031.1/3.7
3.7 - 4.2	4.2	E3 1031.1/4.2
4.2 - 4.7	4.7	E3 1031.1/4.7
4.7 - 5.2	5.2	E3 1031.1/5.2
5.2 - 5.7	5.7	E3 1031.1/5.7
5.7 - 6.2	6.2	E3 1031.1/6.2
6.2 - 6.7	6.7	E3 1031.1/6.7
6.7 - 7.2	7.2	E3 1031.1/7.2

U
UNSHIELDED

Unshielded, one-piece cable clamp.

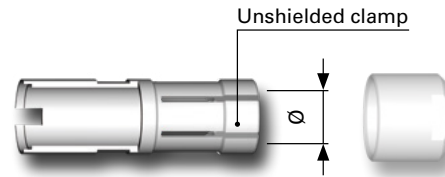

Cable dia. range	Collet Ø	Cable clamp set
2.2 - 2.7	2.7	E3 1031.6/2.7
2.7 - 3.2	3.2	E3 1031.6/3.2
3.2 - 3.7	3.7	E3 1031.6/3.7
3.7 - 4.2	4.2	E3 1031.6/4.2
4.2 - 4.7	4.7	E3 1031.6/4.7
4.7 - 5.2	5.2	E3 1031.6/5.2
5.2 - 5.7	5.7	E3 1031.6/5.7
5.7 - 6.2	6.2	E3 1031.6/6.2
6.2 - 6.7	6.7	E3 1031.6/6.7
6.7 - 7.2	7.2	E3 1031.6/7.2

E
ENVIRONMENTAL

Environmentally sealed clamp for use with shielded or unshielded cables.

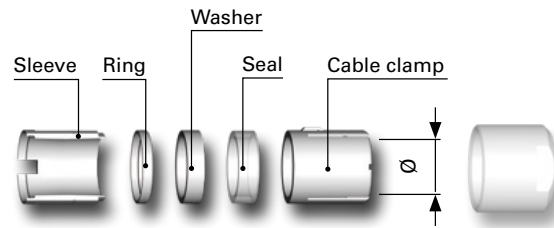

Cable dia. range	Collet Ø	Cable clamp set
2.2 - 2.7	2.7	E3 1031.2/2.7
2.7 - 3.2	3.2	E3 1031.2/3.2
3.2 - 3.7	3.7	E3 1031.2/3.7
3.7 - 4.2	4.2	E3 1031.2/4.2
4.2 - 4.7	4.7	E3 1031.2/4.7
4.7 - 5.2	5.2	E3 1031.2/5.2
5.2 - 5.7	5.7	E3 1031.2/5.7
5.7 - 6.2	6.2	E3 1031.2/6.2
6.2 - 6.7	6.7	E3 1031.2/6.7

104 SERIES

S SHIELDED

Shielded cable clamp with sleeve and clamp.

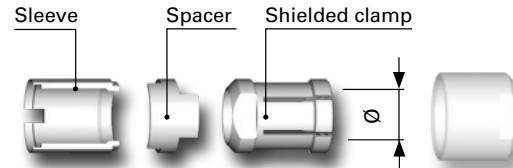

Cable dia. range	Collet Ø	Cable clamp set PEEK or PBT insulator
		Plug
2.9 - 4.0	4.0	E3 104.3/4.0 + B
4.0 - 4.7	4.7	E3 104.3/4.7 + B
4.7 - 5.7	5.7	E3 104.3/5.7 + B
5.7 - 6.7	6.7	E3 104.3/6.7 + B
6.7 - 7.7	7.7	E3 104.3/7.7 + B
7.7 - 8.7	8.7	E3 104.3/8.7 + B
8.7 - 9.1	9.1	E3 104.3/9.1 + B

U UNSHIELDED

Unshielded, one-piece cable clamp.

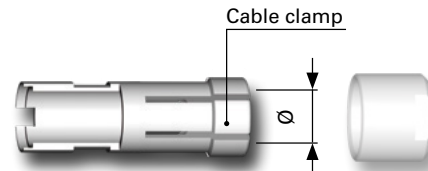
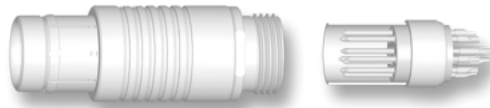

Cable dia. range	Collet Ø	Cable clamp set PEEK or PBT insulator
		Plug
4.2 - 4.7	4.7	E3 104.6/4.7
4.7 - 5.7	5.7	E3 104.6/5.7
5.7 - 6.7	6.7	E3 104.6/6.7
6.7 - 7.7	7.7	E3 104.6/7.7
7.7 - 8.2	8.2	E3 104.6/8.2
8.2 - 8.7	8.7	E3 104.6/8.7

E ENVIRONMENTAL

Environmentally sealed clamp for use with shielded or unshielded cables.

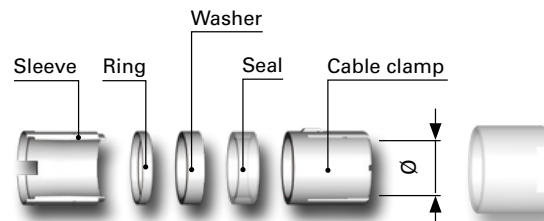

Cable dia. range	Collet Ø	Cable clamp set PEEK or PBT insulator
		Plug
2.9 - 4.0	4.0	E3 104.2/4.0 + B
4.0 - 4.7	4.7	E3 104.2/4.7 + B
4.7 - 5.7	5.7	E3 104.2/5.7 + B
5.7 - 6.7	6.7	E3 104.2/6.7 + B
6.7 - 7.7	7.7	E3 104.2/7.7 + B
7.7 - 8.7	8.7	E3 104.2/8.7 + B

105 SERIES

S
SHIELDED

Shielded cable clamp with sleeve and clamp.

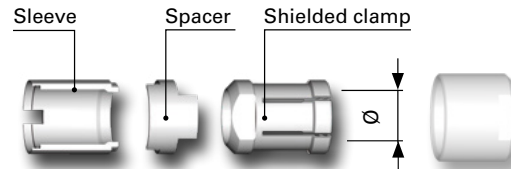

Cable dia. range	Collet Ø	Cable clamp set PEEK or PBT insulator
3.2 - 4.2	4.2	E3 105.1/4.2 + B
4.2 - 5.2	5.2	E3 105.1/5.2 + B
5.2 - 6.2	6.2	E3 105.1/6.2 + B
6.2 - 7.2	7.2	E3 105.1/7.2 + B
7.2 - 8.2	8.2	E3 105.1/8.2 + B
8.2 - 9.2	9.2	E3 105.1/9.2 + B
9.2 - 10.0	10.0	E3 105.1/10.0 + B
10.0 - 10.7	10.7	E3 105.1/10.7 + B

U
UNSHIELDED

Unshielded, one-piece cable clamp.

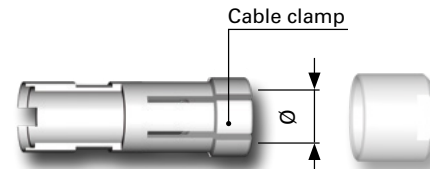

Cable dia. range	Collet Ø	Cable clamp set PEEK or PBT insulator
2.5 - 3.5	3.5	E3 105.6/3.5
3.5 - 4.5	4.5	E3 105.6/4.5
4.5 - 5.5	5.5	E3 105.6/5.5
5.5 - 6.5	6.5	E3 105.6/6.5
6.5 - 7.5	7.5	E3 105.6/7.5
7.5 - 8.5	8.5	E3 105.6/8.5
8.5 - 9.5	9.5	E3 105.6/9.5
9.5 - 10.5	10.5	E3 105.6/10.5

E
ENVIRONMENTAL

Environmentally sealed clamp for use with shielded or unshielded cables.

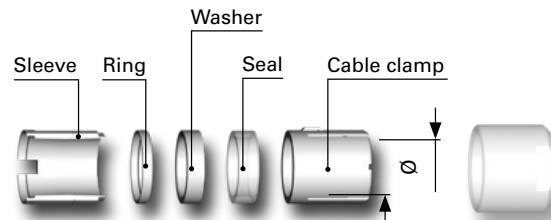



Cable dia. range	Collet Ø	Cable clamp set PEEK or PBT insulator
3.2 - 4.2	4.2	E31 105.2/4.2 + B
4.2 - 5.2	5.2	E31 105.2/5.2 + B
5.2 - 6.2	6.2	E31 105.2/6.2 + B
6.2 - 7.2	7.2	E31 105.2/7.2 + B
7.2 - 8.2	8.2	E31 105.2/8.2 + B
8.2 - 9.2	9.2	E31 105.2/9.2 + B
9.2 - 10.0	10.0	E31 105.2/10.0 + B
10.0 - 10.7	10.7	E31 105.2/10.7 + B

SOFT CAPS - LANYARD WITH POLYESTER CORD

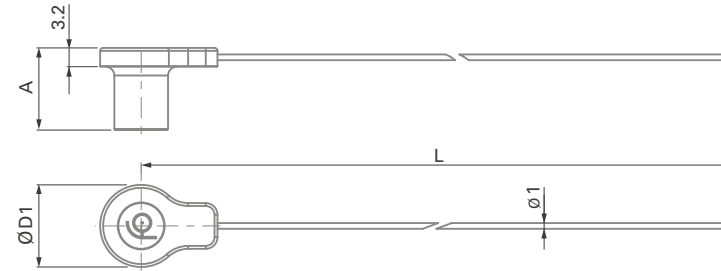
FOR PLUGS







Accessories	Description	Part Number
	Crimp ferrule	300.637
	Crimp lug	300.299
	Heat shrink tube	300.930

Crimp ferrule, crimp lug and heat shrink tube have to be ordered separately.
Material: Cap: Santoprene™ TPV 101-80 / Cord: Polyester.

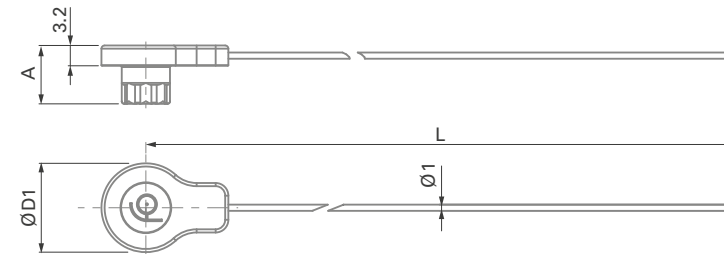
Series	A	D1	L	Part Number
102	14.0	14	200	102.2180
103	14.7	17	200	103.2405
1031	14.0	18	200	1031.1432
104	16.0	20	200	104.2807
105	19.0	23	200	105.3264

FOR RECEPTACLES



Accessories	Description	Part Number
	Crimp ferrule	300.637
	Crimp lug	300.299
	Heat shrink tube	300.930

Series	A	D1	L	Part Number
102	9.2	14	200	102.2181
103	9.7	17	200	103.2406
1031	9.5	18	200	1031.1433
104	10.0	20	200	104.2808
105	10.0	23	200	105.3265

All dimensions and images shown are in millimeters and are for reference only.

SOFT CAPS - ONE-PIECE

FOR PLUGS

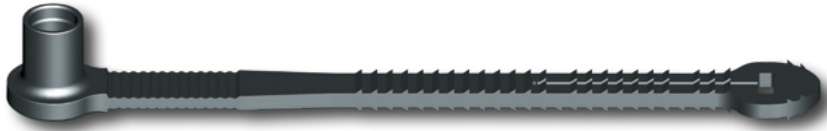

Series	A	D1	L	Part Number
102	14.0	14	122	102.2169
103	14.7	17	147	103.2399
1031	14.0	18	148	1031.1425
104	16.0	20	164	104.2766
105	19.0	23	186	105.3253

Material: Santoprene™ TPV 101-80

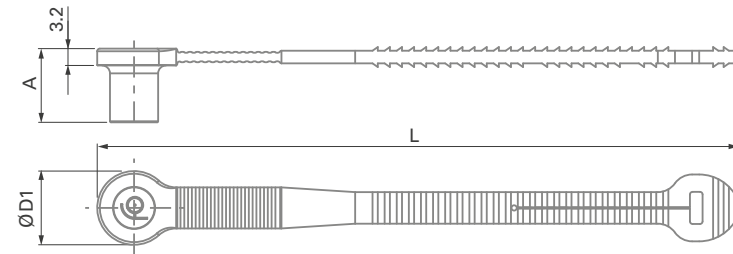

FOR RECEPTACLES



Series	A	D1	L	Part Number
102	9.2	14	122	102.2166
103	9.7	17	147	103.2396
1031	9.5	18	148	1031.1422
104	10.0	20	164	104.2763
105	10.0	23	186	105.3250

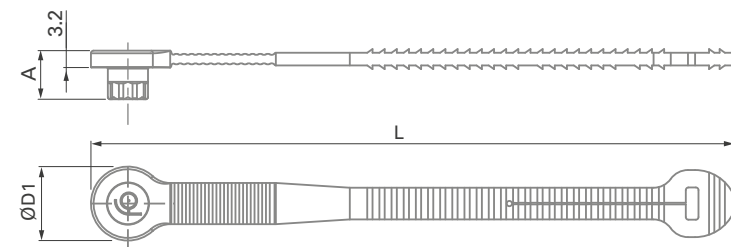

SOFT CAPS - LANYARD WITH STAINLESS STEEL CABLE

FOR PLUGS



Series	A	D1	L	Part Number
102	14.0	14	200	102.2185
103	14.7	17	200	103.2404
1031	14.0	18	200	1031.1431
104	16.0	20	200	104.2806
105	19.0	23	200	105.3263

Crimp ferrule (300.922) and heat shrink tube (300.930) are included.
 Material: Cap: Santoprene™ TPV 101-80 / Cable: Stainless steel with FEP-Teflon® covering

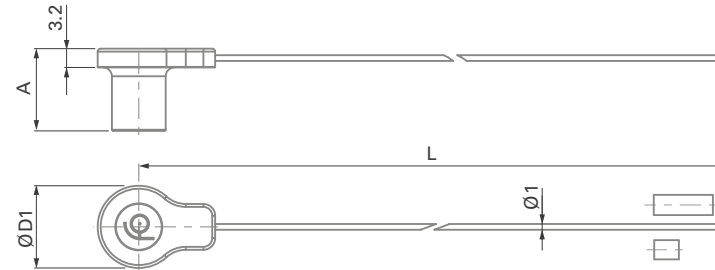

FOR RECEPTACLES



Series	A	D1	L	Part Number
102	9.2	14	200	102.2167
103	9.7	17	200	103.2397
1031	9.5	18	200	1031.1423
104	10.0	20	200	104.2764
105	10.0	23	200	105.3251

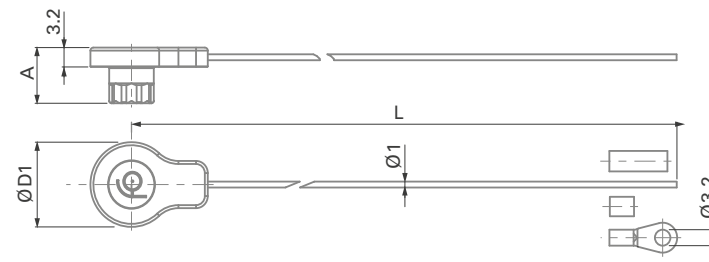

All dimensions and images shown are in millimeters and are for reference only.

SOFT CAPS - LANYARDS WITH STAINLESS STEEL CABLE (PRE-ASSEMBLED)

FOR RECEPTACLES

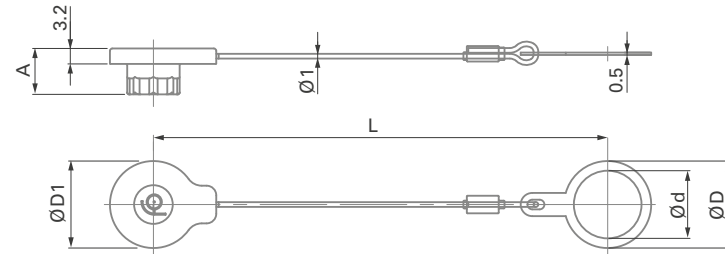

Series	A	D1	L	d	D	Part Number
102	9.2	14	86	9	13	102.2182
	9.2	14	86	10	14	102.2165
103	9.7	17	93	14	18	103.2394
1031	9.5	18	94	14	18	1031.1434
	9.5	18	94	15	20	1031.1420
104	10.0	20	98	16	21	104.2761
105	10.0	23	100	20	25	105.3248

Crimp ferrule, heat shrink tube and fixing lug are included and mounted.

Materials

Cap: Santoprene™ TPV 101-80

Cable: stainless steel with FEP-Teflon® covering

Fixing lug: black chrome plated brass (ISO CuZn37)





Caps are intermateable to provide additional dust protection.

NUT DRIVER FOR SLOTTED NUTS

NUT DRIVER WITH T-HANDLE AND HEX DRIVE

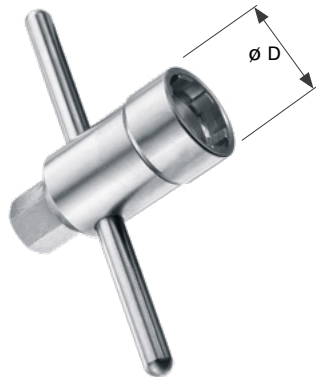
FOR DECORATIVE SLOTTED NUTS 



Thread size	D	 Part number
M9x0.5	15	TC00.000
M10x0.5	16	TC00.007
M14x1	21	TG00.001
M15x1	22	TK00.000
M16x1	23	TK00.002
M20x1	28	TP00.005

Material: hardened tool steel, nickel plated.

All dimensions and images shown are in millimeters and are for reference only.

MECHANICAL & ENVIRONMENTAL DATA

Parameter	Value	Standard
Mating cycles	10,000	IEC 60512-9-1 EIA-364-09
Operating temperature range - Viton O-ring at plug interface - EPDM O-ring (Low temp) at plug interface	-20°C to +200°C -50°C to +160°C See details on page A-9 and B8-32	IEC 60068-2-14
Sealing	IP68; 2m submersion for 24 hours	IEC 60529
Hermeticity - DEE, DBPE, DBPLE	Hermetic: Tested: <10 ⁻⁹ mbar l/s IP69	IEC 60068-2-17 test Qk method 3, alternative b IEC 60529
Vibration	Contact interruption < 1µs (10-2000Hz/15G)	MIL-STD-202 Method 204, Condition B

ELECTRICAL DATA*

Parameter	Series				
	102	103	1031	104	105
Grounding resistance¹⁾ (shell-to-shell)	Typical 50 mΩ				
EMC shielding	360-degree EMC shielding				

¹⁾ IEC 60512-2-6-2f

* Please refer to contact block sections for detailed information.

MATERIAL & SURFACE TREATMENTS

Metal Parts	Material				Finish	
	Designation	Standards			Designation	Standard
		ISO	UNS	EN		
Plug housing - Body - Latching sleeve	Aluminum ¹⁾ Aluminum or Brass	AlMgSi1SnBi CuZn39Pb3	- -	AW-6023 AW-6026	Electroless nickel Sulfuric anodizing or chromium	SAE AMS 2404 MIL-A-8625 SAE AMS 2460
Receptacle housing - Receptacle housing (anodized)	Aluminum ¹⁾	AlMgSi1SnBi	-	AW-6023	Sulfuric anodizing	MIL-A-8625
Grounding - Tag (solder and crimp contacts) - Pin (PCB contacts)	Brass Brass	CuZn39Pb3 CuZn39Pb3	C 38500 C 38500	- -	Electroless nickel Nickel + Flash Gold	SAE AMS 2404
Contacts - Male contacts - Female contacts	Brass Bronze	CuZn39Pb3 CuSn4Zn4Pb4	C 38500 C 54000	- -	Electroless nickel 1 µm Gold	MIL-DTL-45204D Type 1 + ASTM B488

Aluminum is not recommended for marine or corrosive environments. In this case, we recommend the Fischer Core Series Brass or Core Series Stainless Steel.

Insulator and sealing

Contact blocks and other insulators for our standard connectors are manufactured from high performance engineering plastic materials. The standard materials of each connector series are listed under Electrical & Contact configurations in pages B 8-12 through B 8-18. Ceramics and other dielectrics are available on special order.

Insulator and sealing	International symbol	Flammability
Insulator	PEEK - PTFE - PBT	UL 94 V-O
Interface O-rings (receptacles)	FPM (Viton [®]) / EPDM	-
Sealant material - IP68 (receptacles) - Hermetic	Silicon compound Epoxy compound	UL 94 V-O UL 94 HB

Our products are RoHS compliant and conform with the EC Directives 2002/95/EC.

OPERATING TEMPERATURES

The temperature ranges quoted by the manufacturers of the plastic materials are usually the absolute maximum values. When exposed to the mechanical and electrical stresses present in a connector, these values are often unrealistic. If a composite connector system including accessories is used,

then the item with the lowest temperature performance will dictate the operating temperature limit of the system. The table below shows our recommended operating temperature ranges.

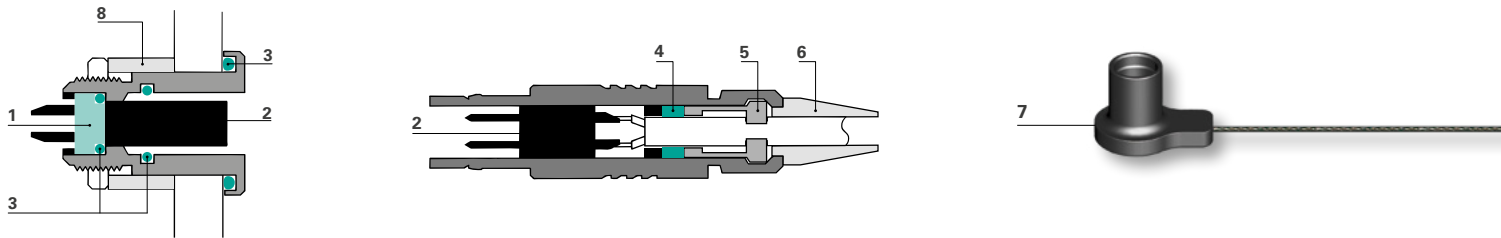

Ref.	Component	Material	Operating temperatures
1	Sealant	"U" Type	-55°C to +200°C
		"E" Type	-65°C to +150°C
2	Insulator	PEEK	-65°C to +250°C
		PTFE (Teflon®)	-65°C to +160°C
		PBT	-65°C to +135°C
3	Standard O-rings	FPM (Viton®)	-20°C to +200°C ¹⁾
	Interface O-rings (option)	EPDM	-50°C to +160°C ²⁾
4	Cable clamp seal	TPE	-70°C to +130°C
5	Cable clamp	Standard Brass	-40°C to +100°C
		High Voltage Connectors POM	-60°C to +100°C
6	Cable strain relief	TPE	-60°C to +180°C
		VMQ - Silicone rubber	-55°C to +85°C
7	Sealing caps	Soft caps TPE	-55°C to +85°C
8	Panel spacer		

¹⁾ Minimum mating temperature: 0°C.

²⁾ Minimum mating temperature: -20°C.

